

FISCHBEIN SEWING HEAD

SERIES D

PARTS ILLUSTRATIONS



MAINTENANCE INSTRUCTIONS



ADJUSTMENTS



Copyright 1961

By

The Don Marshall Company, Inc.
235 Maple Street - PO Box 124
Plain City, Ohio 43064
614-873-8520, Fax: 614-873-8338
info@donmarshall.net

U.S.A. and Foreign Pats. Other Pats. Pending

MAINTENANCE

Clean and oil machine daily. For best results, use genuine Fischbein Cleaning Solvent and Lubricating Oil obtainable from the Dave Fischbein Company or any Authorized Representative. Wash out dirt as follows: Unthread needle. With machine running, dip portion shown, Fig. No. 1, in three or four inches of solvent for about 10 seconds. Then in addition to the oil cups on the machine, oil all shafts, feed dog carrier mechanism, and cutting knife parts. (Important: Do not use gasoline or similar as a cleaning solvent.)

If machine skips stitches or fails to chain off, the cause could be any of the following: Excessive wear, requiring rebuilding or servicing; improper threading or tension (see special instructions on threading and tension enclosed with this form); bent or incorrectly installed needle; damaged or misadjusted looper; incorrect needle bar setting. To check these adjustments or replace these parts, carefully follow instructions listed below:

Do not disturb main bearing, part No. D605, or looper cam, part No. D310. They are timed and set at factory.

NEEDLE INSTALLATION

Insert new needle into needle bar as far as it will go, with the long groove facing exactly outside of machine. The long groove will enter into bar. Lock needle securely with wrench provided with machine. See Fig. No. 2.

LOOPER INSTALLATION

Remove needle, throat plate, feed dog, and presser foot. (To remove presser foot, loosen the two presser foot set screws, remove needle bar guard, part No. D101. Using a screwdriver as a lever, lift up the presser bar clamp, part No. D405, which will allow the presser foot sufficient clearance to slide off the bottom of presser bar. DO NOT loosen or alter setting of the presser bar clamp, part No. D405.) Loosen looper set screw, No. SS832316 and remove old looper. Insert new looper, making sure that it is down in the looper holder, part No. D301-1, as far as it will go. Securely tighten looper set screw against flat on looper shank. Install new straight needle. NOTE: The point of the looper must pass through the center of the needle scarf with about 1/64" clearance between looper point and needle. See "A," Fig. No. 3. (The scarf is the hollowed out section just above the eye of the needle. See Fig. No. 3.) Unless the looper holder and/or needle bar have moved or have slipped, the looper will time up automatically. If necessary, adjust clearance between looper point and needle by loosening the looper holder clamp screw and sliding the looper holder in or out on looper shaft as required. See next paragraph for needle bar setting.

LOOPER TIMING ADJUSTMENT

This adjustment does not have to be made when replacing the looper, but only after looper shaft, looper cam, or cam follower has been replaced.

The looper stroke is correct when there is approximately 1/32" between looper point and edge of needle when looper is at maximum back stroke. See "D," Figure No. 4. To adjust, first rotate machine in sewing direction so that looper is at maximum back stroke position, then loosen clamp screw No. SC54058 in part No. D307 and move looper as necessary.

NEEDLE BAR ADJUSTMENT

Remove needle bar guard, part No. D101. Turn machine pulley in normal sewing direction until looper is in approximate position shown in Fig. No. 5 as needle is on the upstroke. Slightly loosen clamping screw on needle bar clamp, part No. D502. Raise or lower needle bar and/or turn machine pulley to bring looper point flush with or not more than 1/64" ahead of edge of needle, see "B," Fig. No. 5, and to align bottom edge of looper flush with top of needle eye, see "C," Fig. No. 5. Do not change looper setting. Securely lock needle bar clamp and replace needle bar guard. Recheck for proper needle/looper clearance, Fig. No. 3.

STITCH LENGTH

The length of stitch is 3½ to the inch, when, at their highest point, the teeth of the feed dog protrude 3/32" above the throat plate. If the stitches shorten up, check the following:

1. Teeth on feed dog may be worn down. Feed dog must then be replaced.
2. Feed dog may have slipped so that the teeth protrude less than 3/32". Merely raise the feed dog by raising the adjusting screws No. HD64038 located on the feed carrier block. Note that there is a set of locking screws No. HD64038 on the under side of the feed carrier block.

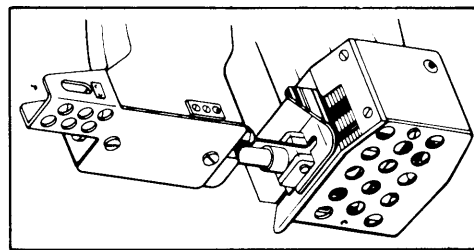

Figure No. 1

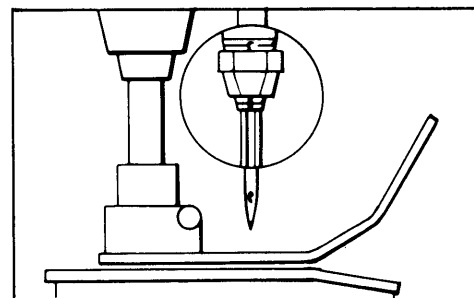

Figure No. 2

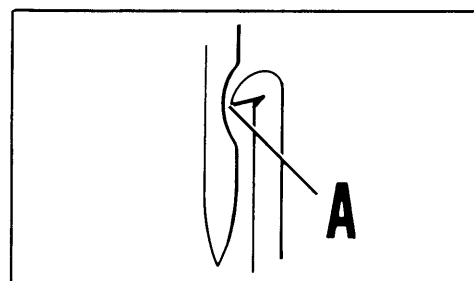

Figure No. 3

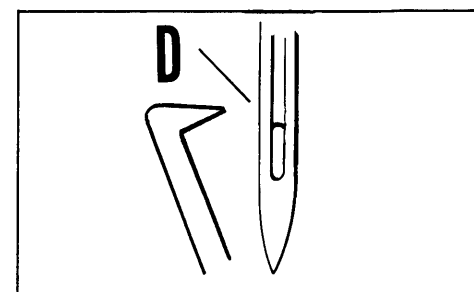

Figure No. 4

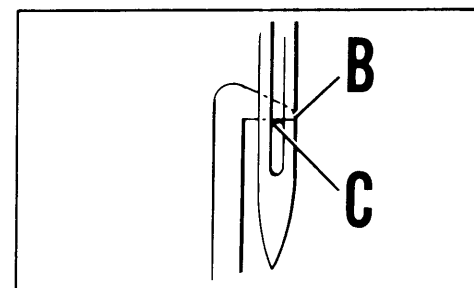

Figure No. 5

REFERENCE PLATE A

ORDER BY PART NUMBER

INDEX NO.	PART NO.	DESCRIPTION	QUANTITY
1	D100	Housing, Complete with Bushings	1
	DH100	Housing, Complete with Bushings, Model DH	1
	DB100	Housing, Complete with Bushings, Model DB	1
	SS832316	Screw, for all Bushings	8
	D121	Oiler	5
2	D119	Cover, Top	1
	0632516	Screw, Attaching, for D119	2
3	D103	Cover, Side Nameplate	1
	DB103	Cover, Side Nameplate, for Model DB	1
	B83214S	Screw, Attaching, for D103 and DB103	4
4	D513	Lock Ring	2
5	D512	Bearing, Cone	2
6	D214	Stud, Feed Dog Carrier Slide	1
	SB103214	Screw, Attaching, for D214	2
7	D102	Cover, Looper	1
	D108	Screw, Attaching, for D102	1
8	D210	Throat Plate	1
	D210T	Throat Plate, Tape Binding	1
	F64038	Screw, Attaching, for D210 and D210T	3
9	D101	Guard, Needle Bar	1
	B832316	Screw, Attaching, for D101	3
10	D110	Tube, Thread Guide, Front	1
	SS54018	Screw, Set, for D110	1
11	D111	Plate, Thread Guide	1
	F348316	Screw, Attaching for D111	2
12	D400	Presser Foot, Complete	1
	D400T	Presser Foot, Complete, Tape Binding	1
	SS832316FP	Screw, set, for D400 and D400T	2
	D402	Bolt, Hinging, for D400 and D400T	1
	D403	Nut, for D402	1
13	D413	Bushing, Presser Bar, Lower	1
14	D414	Spring, Presser Bar	1
15	D405	Clamp, Presser Bar, Complete	1
	SC54012	Screw, Clamping, for D405	1
16	D404	Presser Bar	1
17	D412	Bushing, Presser Bar, Upper	1
18	D407	Lifter Lever, Complete	1
19	T83212	Screw, Attaching, for D407	1
20	D410	Washer, Felt	1
21	D417	Locknut	1
22	D5	Needle	1
23	D501	Locknut, Needle	1
24	D504	Bushing, Needle Bar, Lower	1
25	D502	Clamp, Needle Bar, Complete	1
	SC54012	Screw, Clamping, for D502	1
26	D500	Needle Bar	1
27	D503	Bushing, Needle Bar, Upper	1
28	D505	Lever, Needle Bar	1
	SS83238	Screw, for D505	2
29	D511	Stud, Needle Bar Lever	1
32	D507	Stud, Connecting Rod End	1
33	D510	Spring	1
34	D208	Washer, for H103212	1
35	H103212	Bolt, Retaining, for D607	1
36	F64038	Screw, Tension Nut Retaining	1
37	D116	Nut, Tension, Upper	1
38	D120	Lockwasher	1
39	D117	Nut, Tension, Lower	1
40	D115	Spring, Tension	1
41	D114	Disc, Tension	2
42	D113	Stud, Tension	1
43	D109	Eyelet	1
44	D118	Tube, Thread Guide, Rear	1
	B632316	Screw, Attaching, for D118	2
45	D109	Eyelet	1
46	D607	Bearing, Rod End	1
47	D608	Locknut, for D607	1

PLATE B

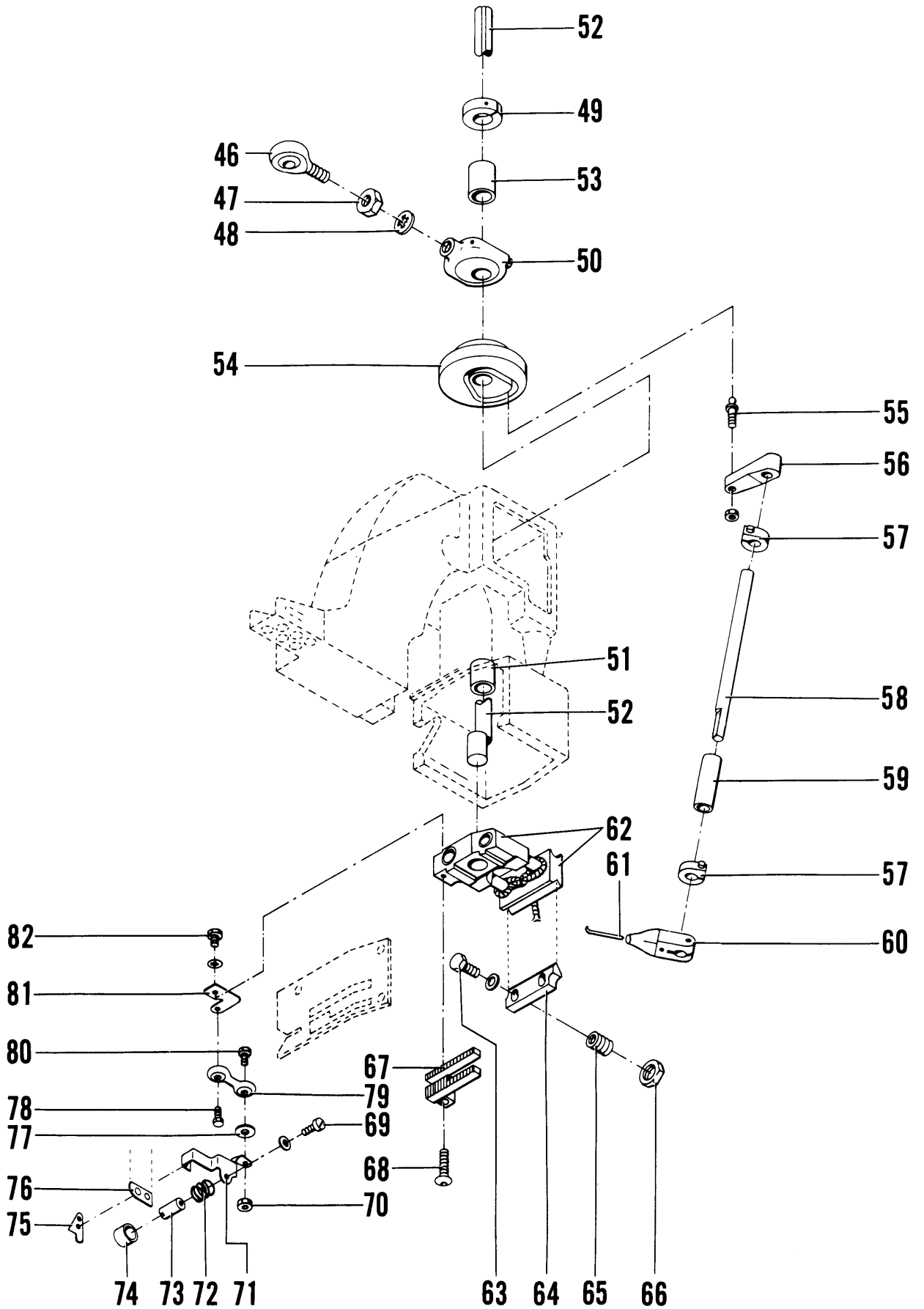

REFERENCE PLATE B

ORDER BY PART NUMBER

INDEX NO.	PART NO.	DESCRIPTION	QUANTITY
48	D609	Lockwasher	1
49	D603	Collar, Retaining, for D600	1
	SC54038	Screw, Clamping, for D603	1
50	D605	Connecting Rod and Eccentric, Complete	1
	D606	Screw, Cone Point, for D605	1
	SS1032316	Screw, Set, for D605	1
51	D602	Bushing, Main Shaft, Front	1
	DB602	Bushing, Main Shaft, Front, Model DB Only	1
52	D600	Main Shaft	1
53	D601	Bushing, Main Shaft, Rear	1
	DB601	Bushing, Main Shaft, Rear, Model DB Only	1
54	D310	Cam, Looper, Complete	1
	D311	Screw, Cone Point, for D310	1
	SS103212	Screw, Set, for D310	1
55	D308	Stud, Cam Follower (order complete with D307)	1
	D309	Locknut, for D308	1
56	D307	Arm, Cam Follower (order complete with D308)	1
	SC54058	Screw, for D307	1
	D313	Washer	1
57	D304	Collar, Looper Shaft	2
	SC54012	Screw, Clamping, for D304	1
58	D303-1	Shaft, Looper	1
59	D306	Bushing, for D303-1	1
60	D301-1	Holder, Looper	1
	SS832316 FP	Screw, Looper Set	1
	SC54038	Screw, Clamping, for D301-1	1
61	D300	Looper	1
62	D200	Feed Dog Carrier Block and Slide, Complete	1
	HD64038	Screw, Feed Dog Adjusting	4
63	H103212	Lock Bolt	2
	D208	Washer, for H103212	2
64	D205	Slide Block, Adjusting	1
65	D206	Stud, Slide Block Adjusting Support	2
66	D209	Locknut, for D206	2
67	D203	Feed Dog	1
68	SC8321	Screw, Attaching, for D203	1
	WF 85	Washer for SC8321	1
69	H1032516	Bolt, Knife Bracket	1
	D714	Lockwasher, for H1032516	1
70	D711	Locknut	1
71	D700	Bracket, Knife	1
72	D704	Spring, Knife Tension	1
73	D707	Shaft	1
74	D708	Bushing, for D707	1
	D708-1	Bushing, for D707, Model DB Only	1
75	D702	Knife, Moving	1
	F348316	Screw, Attaching, for D702	2
76	D703	Knife, Stationary	1
	F348516	Screw, Attaching, for D703	2
77	D715	Washer	1
78	SC54038	Screw, for D709, Upper	1
79	D709	Bearing, Double Rod End	1
80	D710	Bolt, for D709, Lower	1
81	D712	Extension, Knife Bracket Support	1
82	H832516	Bolt, Attaching, for D712	1
	D716	Lockwasher, for H832516	1

— 3
— 4
— 5

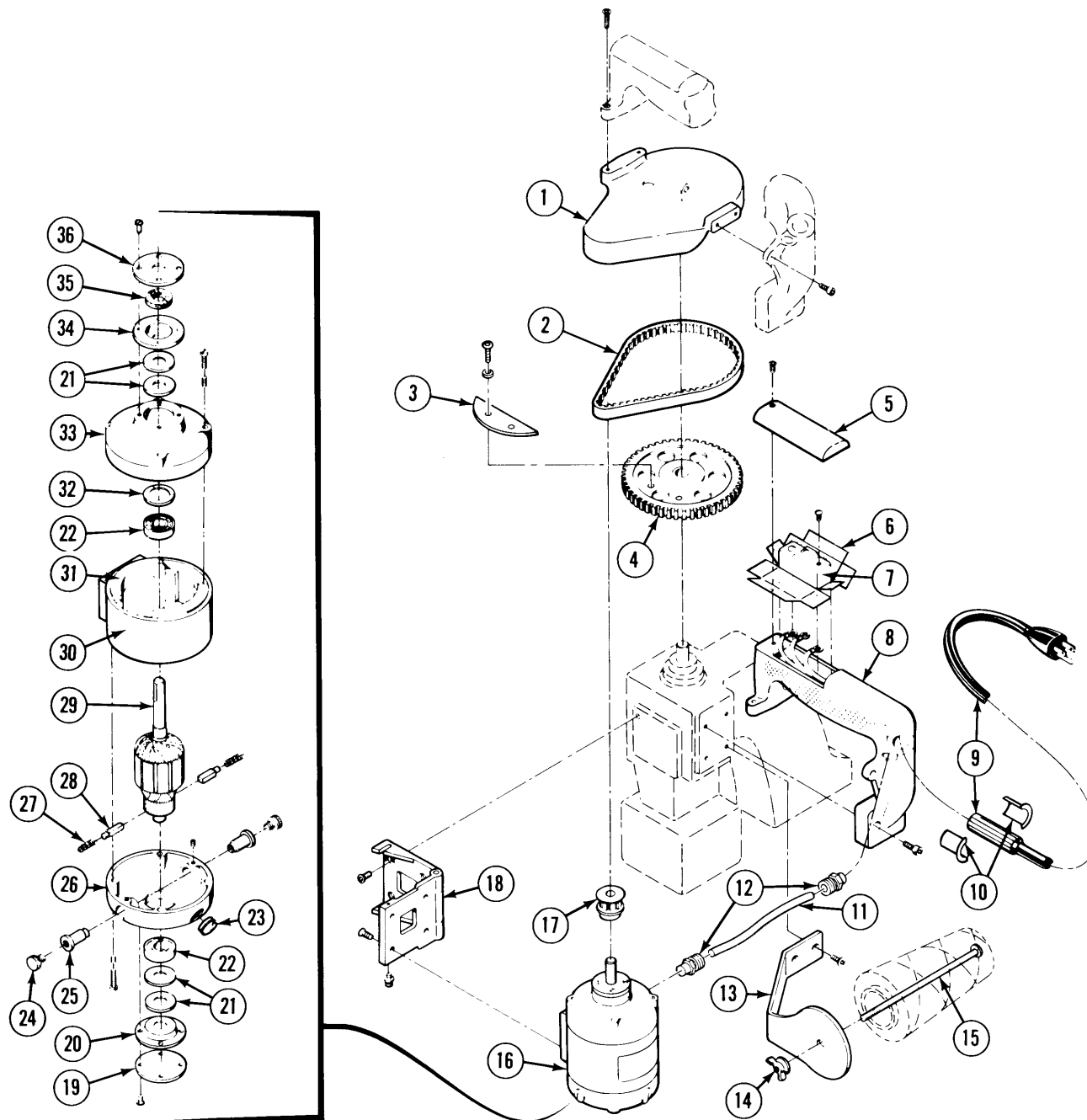

FISCHBEIN PORTABLE BAG CLOSER—MODEL D
HANDLE AND ELECTRIC DRIVE

PARTS LIST

ORDEF	PART NUMBER		ORDER BY PAR	JMBER			
INDEX NO.	PART NO.	DESCRIPTION	QUAN-TITY	INDEX NO.	PART NO.	DESCRIPTION	QUAN-TITY
1	D105-1	GUARD, BELT	1	18	D906	HINGED, MOTOR MOUNT	1
	D105-12	GUARD, BELT - 12 VOLT MODEL ONLY	1		D908	SCREW, SEMS LOCKING - FOR D906	2
	R83258	SCREW, ATTACHING - FOR D105	4		SF10323 8	SCREW, ATTACHING FOR D906	4
2	D909	BELT	1	19	D927	PLATE, BALL BEARING (CLOSED)	1
	D909-12	BELT - 12 VOLT MODEL ONLY	1		D918	SCREW, BALL BEARING PLATE ATTACHING	4
3	D938	COUNTERWEIGHT	1	20	D953	WASHER, FELT RETAINING (CLOSED END)	1
	WS8	WASHER, LOCK	2	21	D954	WASHER, SPACING	AS REQ'D
	SB83238	SCREW, SOCKET BUTTON	2	22	D955	BALL BEARING	2
4	D904	PULLEY, MACHINE	1		D956	BALL BEARING - FOR 12 VOLT MODEL ONLY	2
	SS1032516	SCREW, FOR D904	2	23	914-1	PLUG, INSPECTION HOLE	1
5	D802	COVER, SWITCH	1	24	D917	SCREW, BRUSH - HOLDER CAP	2
	063212	SCREW, ATTACHING - FOR D802	2	25	D924-1	BRUSH - HOLDER	2
6	D807	INSULATION	1		D924-12-1	BRUSH - HOLDER - FOR 12 VOLT MODEL ONLY	2
	D807DC	INSULATION FOR D806DC	1		D930	SCREW, BRUSH - HOLDER SET	2
7	D806	SWITCH	1	26	D957	END BELL, BRUSH END	1
	D806DC	SWITCH - DIRECT CURRENT ONLY	1		D958	END BELL, BRUSH END - FOR 12 VOLT MODEL ONLY	1
	D814	SCREW, SWITCH TERMINAL GROUND	3		D919	SCREW, ATTACHING - END BELL	4
8	D800	HANDLE - COMPLETE WITH COVER	1	27	D916	SPRING, BRUSH	2
	D800DC	HANDLE - COMPLETE W/COVER FOR USE W/D806DC	1	28	D915	BRUSH	2
	SC142034	SCREW, ATTACHING - FOR D800 AND D800DC	2		D915-12	BRUSH WITH SPRING - FOR 12 VOLT MODEL ONLY	2
9	D808	CORD SET	1	29	D959	ARMATURE, COMPLETE - 115 VOLT	1
	D808-12	CORD SET - 12 VOLT MODEL ONLY	1		D960	ARMATURE, COMPLETE - 230 VOLT	1
10	D809	CLAMP FOR D808	2		D961	ARMATURE, COMPLETE - 12 VOLT	1
	SS832316	SCREW FOR D809	1	30	D925	RING AND FIELD ASSEMBLY COMPLETE - 115 VOLT	1
11	D939	MOTOR LEAD - 3 WIRE SJO	1		D926	RING AND FIELD ASSEMBLY COMPLETE - 230 VOLT	1
12	P3481	GRIP, CORD	2		D925-12	RING AND FIELD ASSEMBLY COMPLETE - 12 VOLT	1
13	D815	THREAD STAND	1	31	D922	FIELD - 115 VOLT	2
	SF103238	SCREW, ATTACHING - FOR D815	2		D923	FIELD - 230 VOLT	2
14	D805	WING NUT	1		D922-12	FIELD - 12 VOLT	2
15	D804	BOLT, THREAD CLAMPING	1	32	D962	WASHER, BALL BEARING SPRING	1
16	D950	MOTOR - 115 VOLT	1	33	D963	END BELL, SHAFT END	1
	D951	MOTOR - 230 VOLT	1		D919	SCREW, ATTACHING - END BELL	4
	D952	MOTOR - 12 VOLT DC	1	34	D964	WASHER, FELT RETAINING (OPEN END)	1
	SF103238	SCREW, ATTACHING - FOR ALL MOTORS	4	35	D965	WASHER, FELT	1
17	D902	PULLEY, MOTOR	1	36	D966	PLATE, BALL BEARING (OPEN)	1
	D902-12	PULLEY, MOTOR - 12 VOLT MODEL ONLY	1		D918	SCREW, ATTACHING - FOR D966	4
	SS832316	SCREW - FOR D902	2				
	SS836316	SCREW - FOR D902-12	2				
	D907-12	SPACER - FOR 12 VOLT MODEL ONLY	4				
	SF103258	SCREW, FOR D907-12	4				

MOTOR INSTRUCTIONS

This motor is intermittent duty, which means that it should not run for long periods of time continuously. It is made for start and stop operations only, such as required by bag closing.

Brushes should be inspected at regular intervals so that wear can be detected, and replaced before they are about 1/8" in length. To remove brushes, take out two screws from each side of motor; when replacing brush, be sure it is replaced at the same axial position as removed. If it isn't, excessive sparking and loss of power will result. New brushes are furnished with machine and can be purchased from us at any time.

No motor will operate properly unless the bearings are kept well lubricated. Ball bearings are packed with grease sufficient for a period of from one to two years, depending on the service given the motor and temperature of the room in which it operates. To refill, remove the end caps covering the bearings and clean out the old grease before putting in the new. If the ball bearings are removed for washing in gasoline, the built-in grease seal should be facing toward the motor interior when replaced. Use only well known make of SODIUM BASE BALL BEARING GREASE.